

TULLEVA

Kunskap & kvalitet sedan 1985

08 - 574 103 50



Step Contact Voltage Measuring System

MI 3295

Instruction manual

Version 1.3, Code no. 20 751 785

Distributor:

Manufacturer:

METREL d.d.
Ljubljanska cesta 77
1354 Horjul
Slovenia
web site: <http://www.metrel.si>
e-mail: metrel@metrel.si



Mark on your equipment certifies that this equipment meets the requirements of the EU (European Union) concerning safety and electromagnetic compatibility regulations

© 2010 METREL

The trade names Metrel, Smartec, Eurotest, Autosequence are trademarks registered or pending in Europe and other countries.

No part of this publication may be reproduced or utilized in any form or by any means without permission in writing from METREL.

Table of content

1	Preface	5
2	Safety and operational considerations	6
2.1	Warnings and notes.....	6
2.2	Battery and charging of MI 3295M.....	6
2.2.1	New battery cells or cells unused for a longer period.....	8
2.3	Standards applied.....	8
3	Instrument description MI 3295M Meter	10
3.1	Front panel	10
3.2	Connector panel	11
3.3	Back site	11
4	Instrument description MI 3295S Station	13
4.1	Front panel	13
4.2	Instrument set and accessories	14
4.2.1	Standard set.....	14
4.2.2	Optional accessories	14
5	MI 3295M Meter operation	15
5.1	Organization of display	15
5.1.1	Battery indication.....	15
5.1.2	Warnings and messages.....	15
5.2	Backlight and contrast adjustments	16
5.3	Function selection.....	16
5.4	Settings.....	16
5.4.1	Language.....	17
5.4.2	Help screens.....	17
5.4.3	Initial settings.....	17
5.4.4	Date and time	18
5.4.5	Synchronization.....	18
6	MI 3295S Station operation	20
6.1	Organization of displays	20
6.2	Warnings and messages	20
6.3	Help screens.....	21
6.4	Contrast adjustments.....	21
6.5	Function selection.....	21
6.6	Settings.....	22
6.6.1	Language.....	22
6.6.2	Initial settings.....	22
6.6.3	Date and time	22
6.6.4	Output power range.....	23
6.6.5	Alarm	23
7	Measurements	24
7.1	Theory of measurements.....	24
7.1.1	General on earthing.....	24
7.1.2	General on specific earth resistance	25
7.1.3	Measurement.....	25
7.2	Step and Contact voltage	27
7.2.1	Injection of test current	27

7.2.2	Synchronization before the test (recommended).....	28
7.2.3	Step voltage / Contact voltage measurements.....	29
7.2.4	Synchronization after the test (recommended).....	30
7.3	Earth resistance.....	30
7.3.1	Earth resistance measurement.....	30
7.3.2	Specific earth resistance measurement	31
8	Data handling.....	33
8.1	Memory.....	33
8.1.1	Data structure	33
8.1.2	Storing test results.....	34
8.1.3	Recalling test results	34
8.1.4	Clearing stored data	35
8.2	Current Logger.....	37
8.2.1	Clearing the logger content	37
8.3	Communication.....	38
9	Maintenance.....	39
9.1	Fuse replacement.....	39
9.2	Cleaning	39
9.3	Periodic calibration	39
9.4	Service.....	39
10	Technical specifications	40
10.1	Step voltage, Contact voltage.....	40
10.2	Current.....	40
10.3	Resistance to earth.....	40
10.4	Specific earth resistance.....	41
10.5	General data.....	41

1 Preface

Congratulations on your purchase of the measuring system from METREL.

The Step Contact Voltage Measuring System consists of Station (MI 3295S) and Meter (MI 3295M) and is intended for the following tests and measurements:

- ❑ Step voltage
- ❑ Contact voltage
- ❑ Earth resistance
- ❑ Specific earth resistance

The instrument is equipped with all the necessary accessory for comfortable testing. The PCSW HVlink PRO enables downloading of results, storing of results and making test reports.

Some measuring system highlights:

- ❑ Graphic LCD displays on Meter and Station.
- ❑ Autonomous Step / Contact Voltage Meter(s).
- ❑ Over 1000 memory locations in data flash memory for storing test results & parameters.
- ❑ USB and RS232 ports on Meter for communication with PC.
- ❑ Synchronization between Meter and Station.
- ❑ Large test current of up to 50 A.
- ❑ Stable and accurate results due to a DSP measuring system.
- ❑ Fully compatible with new METREL HVLink PRO PC software package.

2 Safety and operational considerations

2.1 Warnings and notes

In order to reach high level of operator's safety while carrying out various tests and measurements using the Step Contact Voltage Measuring System, as well as to keep the equipment undamaged, it is necessary to consider the following general warnings:

- ❑  **Warning on the instrument means »Read the Instruction manual with special care to safety operation«. The symbol requires an action!**
- ❑ **If the test equipment is used in a manner not specified in this user manual the protection provided by the equipment might be impaired!**
- ❑ **Read this user manual carefully, otherwise use of the instrument may be dangerous for the operator or for the instrument!**
- ❑ **All normal safety precautions have to be taken in order to avoid risk of electric shock when working in the area of distribution systems!**
- ❑ **Do not use the instrument and accessories if any damage is noticed!**
- ❑ **Service intervention or adjustment and calibration procedure is allowed to be carried out only by a competent authorized person!**
- ❑ **Use only standard or optional test accessories supplied by your distributor!**

Meter (MI 3295M)

- ❑ **Instrument contains rechargeable NiMh battery cells. The cells should only be replaced with the same type as defined on the battery placement label or in this manual. Do not use standard alkaline battery cells while power supply adapter is connected, otherwise they may explode!**
- ❑ **Disconnect all test leads, remove the power supply cable and switch off the instrument before removing battery compartment cover.**
- ❑ **The weight of each test probe is 25 kg. This weight may be harmful if the probes are not lifted and carried appropriately.**

Station (MI 3295S)

- ❑ **During instrument operation ventilation holes on casing should always stay open to ensure sufficient air-flow for cooling.**
- ❑ **Disconnect all test leads, switch off the instrument and remove the mains cord before changing the fuse.**
- ❑ **The weight of the MI 3295S is 29.5 kg. This weight may be harmful if the instrument is not lifted and carried appropriately. It is recommended that the instrument is transported by 2 persons.**

2.2 Battery and charging of MI 3295M

The instrument MI 3295M uses six AA size alkaline or rechargeable Ni-Cd or Ni-MH battery cells. Nominal operating time is declared for cells with nominal capacity of 2100 mAh. Battery condition is always displayed in the lower right display part.

In case the battery is too weak the instrument indicates this as shown in figure 2.1. This indication appears for a few seconds and then the instrument turns itself off.

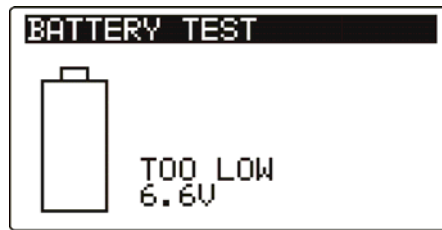

Figure 2.1: Discharged battery indication

The battery is charged whenever the power supply adapter is connected to the instrument. Internal circuit controls charging assuring maximum battery lifetime. The power supply socket polarity is shown in figure 2.2.



Figure 2.2: Power supply socket polarity

The instrument automatically recognizes the connected power supply adapter and begins charging.

Symbols:

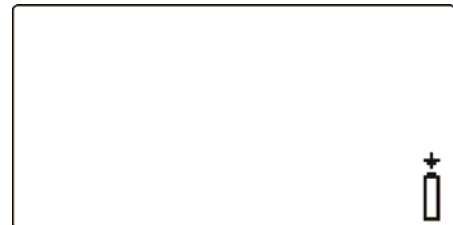
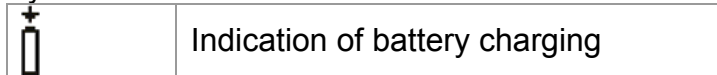

Figure 2.3: Charging indication

- ❑ **⚠ Before opening battery compartment cover disconnect all measuring accessories connected to the instrument and switch off the instrument.**
- ❑ **Do not charge alkaline battery cells!**
- ❑ Insert cells correctly, otherwise the instrument will not operate and the batteries could be damaged.
- ❑ Remove all battery cells from the battery compartment if the instrument is not used for a long period of time.
- ❑ Take into account handling, maintenance and recycling requirements that are defined by related regulations and manufacturers of alkaline or rechargeable batteries!
- ❑ Use only power supply adapter delivered from the manufacturer or distributor of the test equipment to avoid possible fire or electric shock!

2.2.1 New battery cells or cells unused for a longer period

Unpredictable chemical processes can occur during charging of new battery cells or cells that were unused for a longer period (more than 3 months). NiMH and NiCd battery cells are affected to capacity degradation (sometimes called as memory effect). As a result the instrument operation time can be significantly reduced.

Recommended procedure for recovering battery cells:

Procedure	Notes
> Completely charge the battery.	<i>At least 14 h with in-built charger.</i>
> Completely discharge the battery.	<i>Use the instrument for normal testing until the unit displays the "Bat" symbol on screen.</i>
> Repeat the charge / discharge cycle for at least twice.	<i>Four cycles are recommended.</i>

Complete discharge / charge cycle can be performed automatically for each cell using external intelligent battery charger.

Notes:

- ❑ The charger in the instrument is a pack cell charger. This means that the battery cells are connected in series during the charging. The battery cells have to be equivalent (same charge condition, same type and age).
- ❑ One different battery cell can cause an improper charging and incorrect discharging during normal usage of the entire battery pack (it results in heating of the battery pack, significantly decreased operation time, reversed polarity of defective cell,...).
- ❑ If no improvement is achieved after several charge / discharge cycles, then each battery cell should be checked (by comparing battery voltages, testing them in a cell charger, etc). It is very likely that only some of the battery cells are deteriorated.
- ❑ The effects described above should not be confused with the normal decrease of battery capacity over time. Battery also loses some capacity when it is repeatedly charged / discharged. This information is provided in the technical specification from battery manufacturer.

2.3 Standards applied

The Step Contact Voltage Measuring System (MI 3295) is manufactured and tested according to the following regulations, listed below.

Electromagnetic compatibility (EMC)

IEC/ EN 61326-1	Electrical equipment for measurement, control and laboratory use - EMC requirements - Part 1: General requirements Class B (Hand held equipment used in controlled EM environments)
IEC/EN 61326-2-2	Electrical equipment for measurement, control and laboratory use - EMC requirements - Part 2-2: Particular requirements - Test configurations, operational conditions and performance criteria for portable test, measuring and monitoring equipment used in low-voltage distribution systems

Safety (LVD)

IEC/ EN 61010 - 1 Safety requirements for electrical equipment for measurement, control, and laboratory use – Part 1: General requirements

IEC/ EN 61010 – 031 Safety requirements for hand-held probe assemblies for electrical measurement and test

Functionality

HD 637 S1 Power installations exceeding 1 kV a.c.

ANSI/IEEE Std 81 IEEE Guide for Measuring Earth Resistivity, Ground Impedance, and Earth Surface Potentials of a Ground System

RAT 2008 Spain High Voltage regulation

3 Instrument description MI 3295M Meter

3.1 Front panel



Figure 3.1: Front panel

Legend:

1	ESC	Returns to previous menu
2	MEM	Handling with memory
3	Cursor and TEST keys	Cursors Selects test parameters TEST Starts / stops measurement
4	BACKLIGHT, CONTRAST	Changes backlight level and contrast
5	LCD	LCD display with backlight
6	ON / OFF	Switches the instrument power on or off <i>The instrument automatically turns off 15 minutes after the last key was pressed</i>
7,8	Function selector	Selects test function and settings

3.2 Connector panel

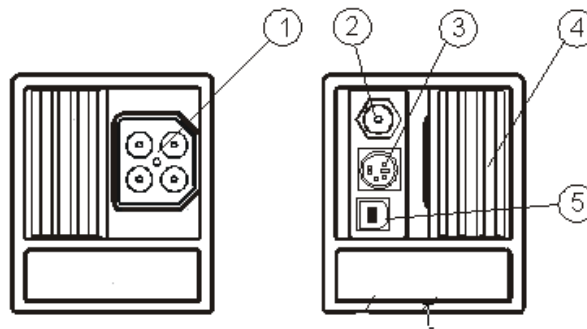

Figure 3.2: Connector panel

Legend:

- | | |
|---|---|
| 1 | Test connector.
Warning! Maximal allowed voltage between test terminals and ground is 50 V!
Maximal allowed voltage between test terminals is 100 V! |
| 2 | Power supply socket |
| 3 | PS/2 connector (for RS232 communication) |
| 4 | Protection cover |
| 5 | USB connector |

3.3 Back site

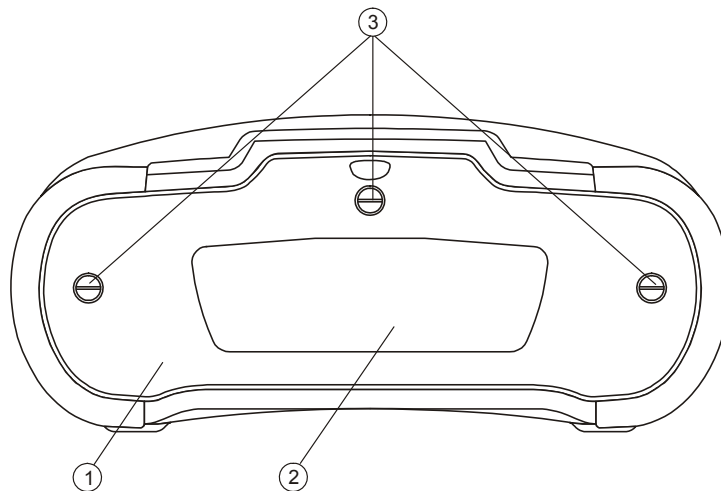

Figure 3.3: Back panel

Legend:

- | | |
|---|---|
| 1 | Battery compartment cover |
| 2 | Information label |
| 3 | Fixing screws for battery compartment cover |

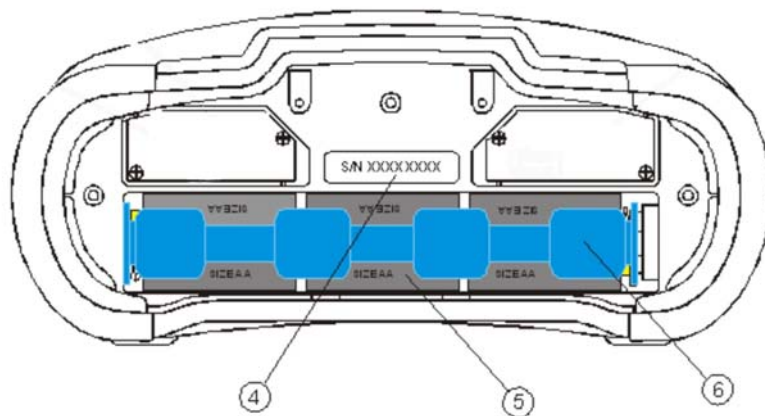

Figure 3.4: Battery compartment

Legend:

1	Serial number label
2	Battery cells (size AA)
3	Battery compartment

4 Instrument description MI 3295S Station

4.1 Front panel

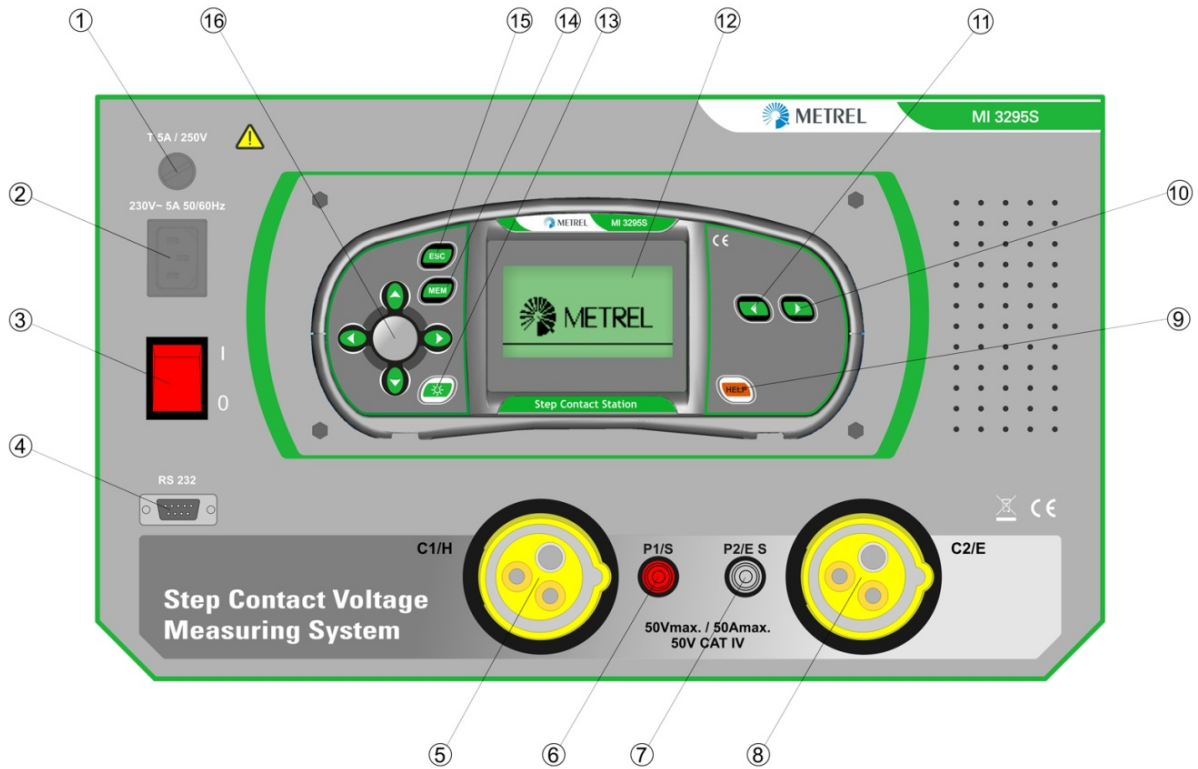

Figure 4.1: Front panel

Legend:

1	Mains fuse	See chapter 9.1 <i>Fuse replacement</i> for more information
2	Mains input	For connection to mains cord
3	Power On/Off switch	
4	RS232 connector	For connection to the Meter
5	C1/H	Connection for auxiliary earthing probe
6	S	Connection for voltage sense probe
7	ES	Connection for second voltage sense probe
8	C2/E	Connection for auxiliary earthing probe
9	HELP	Help menus
10,11	Function selector	Selects test function and settings
12	LCD	LCD display with backlight
13	CONTRAST	Changes contrast
14	MEM	Handling with memory
15	ESC	Returns to previous screen
16	Cursor and TEST keys	Cursors: Selects test parameters TEST: Starts measurement.

4.2 Instrument set and accessories

4.2.1 Standard set

Instrument MI 3295S	1 pc
Instrument MI 3295M	1 pc
Mains cable	1 pc
Step voltage probe (25 kg)	2 pcs
Current earth spike	1 pc
Potential earth spike	1 pc
Current test lead, 50 m, black, 10 mm ² , with crocodile clip, on wheel	1 pc
Current test lead, 10 m, black, 10mm ² , with crocodile clip	1 pc
Test lead, black, 2 x 3 m	1 pc
Test lead, green, 10 m	1 pc
Test lead, red, 50 m	1 pc
Connection lead with crocodile clip, red, 1 m	1 pc
Test lead, black, 1.5 m	1 pc
Crocodile clip	4 pcs
RS232 cable	1 pc
USB cable	1 pc
Soft carrying bag	2 pcs
Soft carrying neck belt	1 pc
NiMH battery, type AA	6 pcs
Power supply adapter	1 pc
CD with instruction manual and PC SW HVLink PRO	1 pc
Instruction manual	1 pc
Calibration certificate	

4.2.2 Optional accessories

See the attached sheet for a list of optional accessories that are available on request from your distributor.

5 MI 3295M Meter operation

5.1 Organization of display

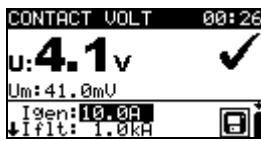

Figure 5.1: Typical function display

CONTACT VOLT	Function name
U: 4.1v ✓	Result field
Um: 41.0mU Igen: 10.0A Ifit: 1.0kH	Test parameter field
	Message field

5.1.1 Battery indication

The battery indication indicates the charge condition of battery and connection of external charger.



Battery capacity indication.



Low battery.

Battery is too weak to guarantee correct result. Replace or recharge the battery cells.



Recharging in progress (if power supply adapter is connected).

Warning:

- If the batteries are removed for more than 1 minute:
- set time and date will be lost
- the instrument will return to Initial settings.

5.1.2 Warnings and messages

In the message field warnings and messages are displayed.



The Meter and Station are not synchronized.



Measurement is running; consider displayed warnings.



Result(s) can be stored.



Measurement result is inside pre-set limits (PASS).



Measurement result is out of pre-set limits (FAIL).

5.2 Backlight and contrast adjustments

With the BACKLIGHT key backlight and contrast can be adjusted.



Figure 5.2: Contrast adjustment menu

BACKLIGHT key:

Click	Toggle backlight intensity level.
Keep pressed for 1 s	Lock high intensity backlight level until power is turned off or the key is pressed again.
Keep pressed for 2 s	Bargraph for LCD contrast adjustment is displayed.

Keys for contrast adjustment:

Cursor LEFT / RIGHT	Sets contrast.
TEST	Confirms new contrast.
ESC	Exits without changes.

5.3 Function selection

For selecting function main menus the **FUNCTION SELECTOR** shall be used:

Function selector	Selects test / measurement function: <ul style="list-style-type: none"> <input type="checkbox"/> <STEP VOLT> step voltage test <input type="checkbox"/> <CONTACT VOLT> contact voltage test <input type="checkbox"/> <SETTINGS> settings / synchronization
--------------------------	---

5.4 Settings

Different instrument options can be set in the SETTINGS menu.

Options are:

- Selection of language
- Help screens
- Synchronization with the Station
- Setting the instrument to initial values
- Recalling and clearing stored results
- Setting date and time

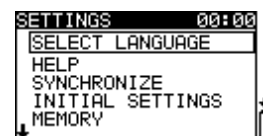

Figure 5.3: Settings menu

Keys:

Cursor UP / DOWN	Selects appropriate option.
TEST	Enters selected option.

5.4.1 Language

Language can be set in the SELECT LANGUAGE menu.



Figure 5.4: Language selection

Keys:

Cursor UP / DOWN	Selects language.
TEST	Confirms selected language.
ESC	Returns to Settings main menu.

5.4.2 Help screens

The help screens contain basic schematic / connection diagrams and information about the instrument.

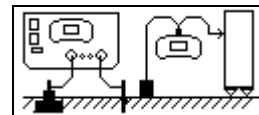

Figure 5.5: Example of help screen

Keys:

Cursor LEFT / RIGHT	Selects next / previous help screen.
ESC	Returns to Settings main menu.

5.4.3 Initial settings

The instrument settings and measurement parameters and limits can be set to their initial (factory) settings in this menu.

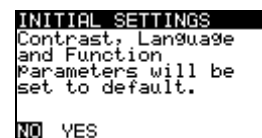

Figure 5.6: Initial settings screen

Keys:

Cursor LEFT / RIGHT	Selects Yes or No
TEST	Restores initial settings (if Yes is selected)
ESC	Exits back to Settings main menu without changes.

Initial settings are:

Instrument setting	Default value
Contrast	Default value
Language	English

Function	Parameters / limit value
Contact Voltage	$I_{SET} = 10 \text{ A}$ $I_{FAULT} = 1 \text{ kA}$ $R_{INPUT} = 1 \text{ M}\Omega$ $U_{LIMIT} = 50 \text{ V}$
Step Voltage	$I_{SET} = 10 \text{ A}$ $I_{FAULT} = 1 \text{ kA}$ $R_{INPUT} = 1 \text{ M}\Omega$ $U_{LIMIT} = 50 \text{ V}$

5.4.4 Date and time

Date and time can be set in this menu.

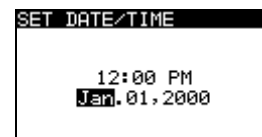

Figure 5.7: Setting date and time

Keys:

Cursor LEFT / RIGHT	Selects the item to be changed.
Cursor UP / DOWN	Modifies selected item.
TEST	Confirms new setup and exits.
ESC	Returns to Settings main menu.

5.4.5 Synchronization

Selecting this option will allow to upload different data from the Station to the Meter and vice versa.

Options are:

- Synchronization of date, time and current
- Uploading of test current results for Step / Contact voltage calculation
- Uploading of earth resistance results

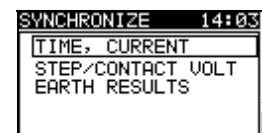

Figure 5.8: Synchronization menu

Keys:

Cursor UP / DOWN	Selects option.
TEST	Enters selected option.
ESC	Returns to Settings main menu.

Synchronized data :

TIME, CURRENT	Station's time and date will be uploaded to the Meter. Value of generator current will be uploaded to the Meter (if current generator is on).
STEP/CONTACT VOLT	Values of logged generator currents I_{GEN} will be uploaded to the Meter for calculation of Step voltage or Contact voltage.
EARTH RESULTS	Stored Earth resistance or Specific earth resistance results in the Station will be uploaded to the Meter.

Note:

- The main purpose of the Time/ Current synchronization is to enable a correction of the step and contact voltage results after the test. During the test the step and contact voltage results are calculated on base on the set I_{SET} in the Meter. After the test the results made with the Meter can be updated with the real generator currents I_{GEN} that were measured at the same time with the Station. The stored U_{STEP} and $U_{CONTACT}$ values are then corrected according to the following formula:

$$U_{STEP_{new}} = U_{STEP_{old}} \cdot \frac{I_{GEN(actually_generated)}}{I_{SET}}$$

$$U_{CONT_{new}} = U_{CONT_{old}} \cdot \frac{I_{GEN(actually_generated)}}{I_{SET}}$$

- The synchronization is active for 24 h.
- If the date / time are changed at the Meter or the Station the synchronization of time and data will be lost. The Current logger must be cleared before it can be proceeded with the measurements. Before clearing it the content can be downloaded to the Meter.
- If there is no synchronization between both units the  icon is displayed in the Meter measuring screen.

6 MI 3295S Station operation

6.1 Organization of displays



Figure 6.1: Typical display in earth resistance function

EARTH RE	Function name
R: 0.305 Ω Rc: 0 Ω Rp: 0 Ω	Result & Sub-result field
	Message field



Figure 6.2: Typical display in specific earth resistance function

EARTH e	Function name
2.4m	Test parameter field
p: 0.43 Ωm Rc: 0 Ω Rp: 0 Ω	Result & Sub-result field
	Message field

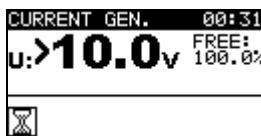

Figure 6.3: Typical display in current function

CURRENT GEN.	Function name
I: 19.9 A	Result field
	Message field
FREE: 93.8%	Remained place in current logger

6.2 Warnings and messages

Before and during the measurement the instrument performs different tests to ensure safety and to prevent from damaging it. These safety tests include checking for any external voltage or improper loading of test terminals. If a problem is detected, an appropriate warning message will be displayed. Warnings and protective measures are described in this chapter.



Voltage between test terminals C1/H and C2/E is higher than allowed (>10 V). Disconnect the test leads and check why an external voltage was detected!

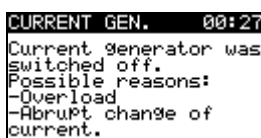

Output was overloaded or test current abruptly fall down. Overload can be caused by high spurious earth current. In this case it is recommended to decrease the output power. See chapter 6.6.4 *Output power range* for more information.

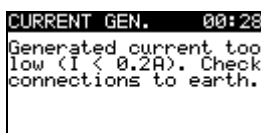

Output current is too low. A too low current can be caused because of bad connection or high probe resistance.

```

CURRENT GEN. 00:22
TIME WAS CHANGED.
LOGGED CURRENTS MUST
BE CLEARED. STORED
DATA SHOULD BE
DOWNLOADED TO METER.

```

Date / time was changed in the Station and consequentially the synchronization between Station and Meter is lost. The Current logger must be cleared. Before clearing it its content can be downloaded to the Meter.

In the message field warnings and messages are displayed.



Output power is not set to maximum



Measurement is running; consider displayed warnings.



High electrical noise was detected during measurement. Results may be impaired.



High resistance of current (c) and/ or voltage (p) probes. Results may be impaired.



Result(s) can be stored.

6.3 Help screens

Same as in MI 3295M – see chapter 5.4.2 *Help screen*.
The help screens can be accessed with the HELP key.

6.4 Contrast adjustments

With the LIGHT key contrast can be adjusted.



Figure 6.4: Contrast adjustment menu

Keys for contrast adjustment:

Cursor LEFT / RIGHT	Sets contrast.
TEST	Accepts new contrast.
ESC	Exits without changes.

6.5 Function selection

For selecting test function the FUNCTION SELECTOR shall be used:

Function selector	Selects test / measurement function. <input type="checkbox"/> <EARTH RE, EARTH ρ > earth resistance <input type="checkbox"/> <CURRENT GEN.> generation of measuring current <input type="checkbox"/> <SETTINGS> settings
Cursor UP / DOWN	Selects sub-function in selected measurement function.
Cursor LEFT / RIGHT	Selects the test parameter to be modified.

Keys in **test parameter** field:

Cursor UP / DOWN	Changes the selected parameter.

6.6 Settings

Different instrument options can be set in the SETTINGS menu.

Options are:

- ❑ Selection of language
- ❑ Setting the instrument to initial values
- ❑ Setting the output power of the generator
- ❑ Setting the alarm
- ❑ Recalling and clearing results
- ❑ Setting date and time



Figure 6.5: Options in Settings menu

Keys:

Cursor UP / DOWN	Selects appropriate option.
TEST	Enters selected option.
ESC	Exits back to main function menu.

6.6.1 Language

Same as in MI 3295M – see chapter 5.4.1 *Language*.

6.6.2 Initial settings

Selecting this option will allow the user to reset the instrument settings and measurement parameters and limits to the initial (factory) settings.

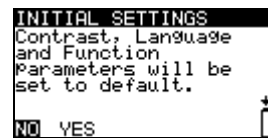

Figure 6.6: Initial settings screen

Keys:

Cursor LEFT / RIGHT	Selects Yes or No
TEST	Restores default settings (if Yes is selected)
ESC	Exits back to Settings main menu without changes.

Initial settings are:

Instrument setting	Default value
Contrast	Default value
Language	English
Alarm	Disabled
Power Range	100%
Distance 'a'	2.0 m

6.6.3 Date and time

Same as in MI 3295M – see chapter 5.4.4 *Date and time*.

6.6.4 Output power range

In this menu the power of the current generator can be set.

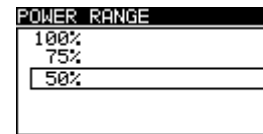

Figure 6.7: Output power menu

Keys:

Cursor UP / DOWN	Selects appropriate option (50%, 75%, 100%)
TEST	Sets selected power.
ESC	Returns to Settings main menu.

Note:

When the current generator is started the output power is automatically set to the available maximum. If the conditions changed during the measurement the generator may switch off. Possible reasons for switching off are:

- The output can become overloaded by high external earth currents. In this case it is recommended to decrease the output power to 75% or 50% and restart the generator.
- The current stopped flowing abruptly. If the stop was caused by disconnection of the leads it is not necessary to lower the power. The generator can be restarted.

6.6.5 Alarm

An audible alarm warns the user that the current generator switched off due to overload or abrupt change of current.

The alarm can be activated / deactivated in this menu.

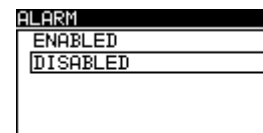

Figure 6.8: Language selection

Keys:

Cursor UP / DOWN	Enables / disables the alarm.
TEST	Confirms selected option.
ESC	Returns to Settings main menu.

Note:

- An enabled alarm helps to prevent from wrong interpretation of the Step and Contact voltage results. The readings will be close to 0 V (a 'pass') if no test current is flowing.

7 Measurements

7.1 Theory of measurements

7.1.1 General on earthing

An earthing electrode / grid depleted into ground has a certain resistance, depending on its size, surface (oxides on the metal surface) and the soil resistivity around the electrode. The earthing resistance is not concentrated in one point but is distributed around the electrode. Correct earthing of exposed conductive parts assures that the voltage on them stays below dangerous level in case of a fault.

If a fault happens a fault current will flow through the earthing electrode. A typical voltage distribution occurs around the electrode (the “voltage funnel”). The largest part of the voltage drop is concentrated around the earth electrode. *Fig. 7.1* shows how fault, step and contact voltages occur as a result of fault currents flowing through the earthing electrode / grid in the ground.

Fault currents close to power distribution objects (substations, distribution towers, plants) can be very high, up to 200 kA. This can result in dangerous step and contact voltages. If there are underground metal connections (intended or unknown) the voltage funnel can get atypical forms and high voltages can occur far from the point of failure. Therefore the voltage distribution in case of a fault around these objects must be carefully analyzed.

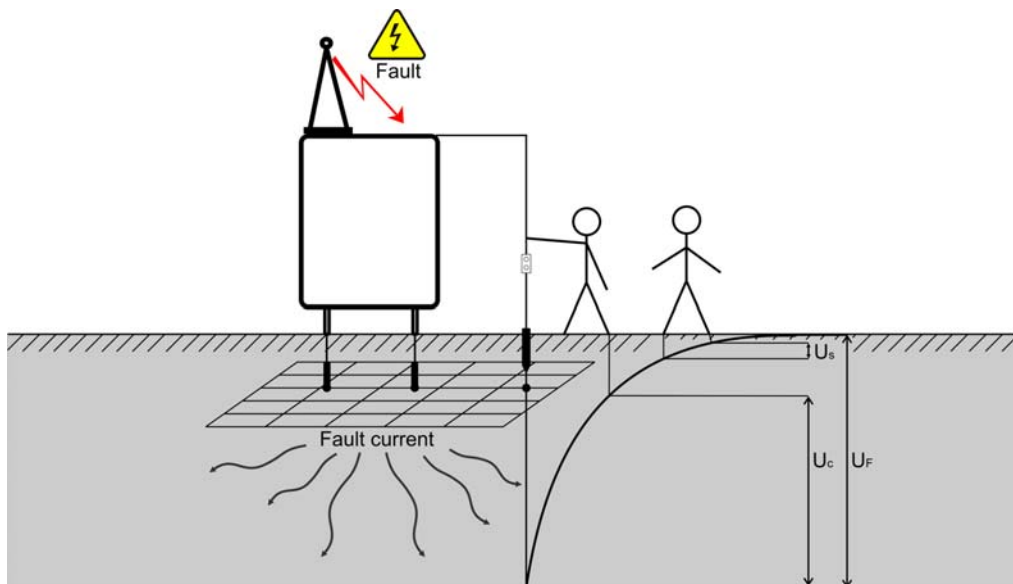

Figure 7.1: Dangerous voltages on a faulty earthing system

Standard IEC 61140 defines following maximum allowed time / contact voltage relations:

Maximum time of exposure	Voltage
>5 s to ∞	$U_C \leq 50 \text{ V}_{AC}$ or $\leq 120 \text{ V}_{DC}$
< 0.4 s	$U_C \leq 115 \text{ V}_{AC}$ or $\leq 180 \text{ V}_{DC}$
< 0.2 s	$U_C \leq 200 \text{ V}_{AC}$
< 0.04 s	$U_C \leq 250 \text{ V}_{AC}$

Table 13: Maximum time durations vs fault voltage

For a longer exposure the touch voltages must stay below 50 V.

7.1.2 General on specific earth resistance

The specific earth resistance (soil resistivity) is measured to determine the characteristic of the soil. The measurement is carried out in order to assure more accurate calculation of earthing systems e.g. for high-voltage distribution columns, large industrial plants, lightning systems etc. The results are used to properly dimension earthing systems (size, depth, number and position of earthing rods). Specific Earth Resistance value is expressed in Ωm .

7.1.3 Measurement

During the measurement a test current is injected into the earth through an auxiliary probe. The resistance of the auxiliary probe should be as low as possible in order to inject a high test current. The resistance can be decreased by using more probes in parallel or using an auxiliary earthing system as the auxiliary probe. A higher injected current improves the immunity against spurious earth currents.

Step voltage

The measurement is performed between two ground points at a distance of 1 m as shown on *Fig. 7.2*. The 25 kg measuring probes simulates the feet. The voltage between the probes is measured by a voltmeter with an internal resistance of 1 k Ω that simulates the body resistance.

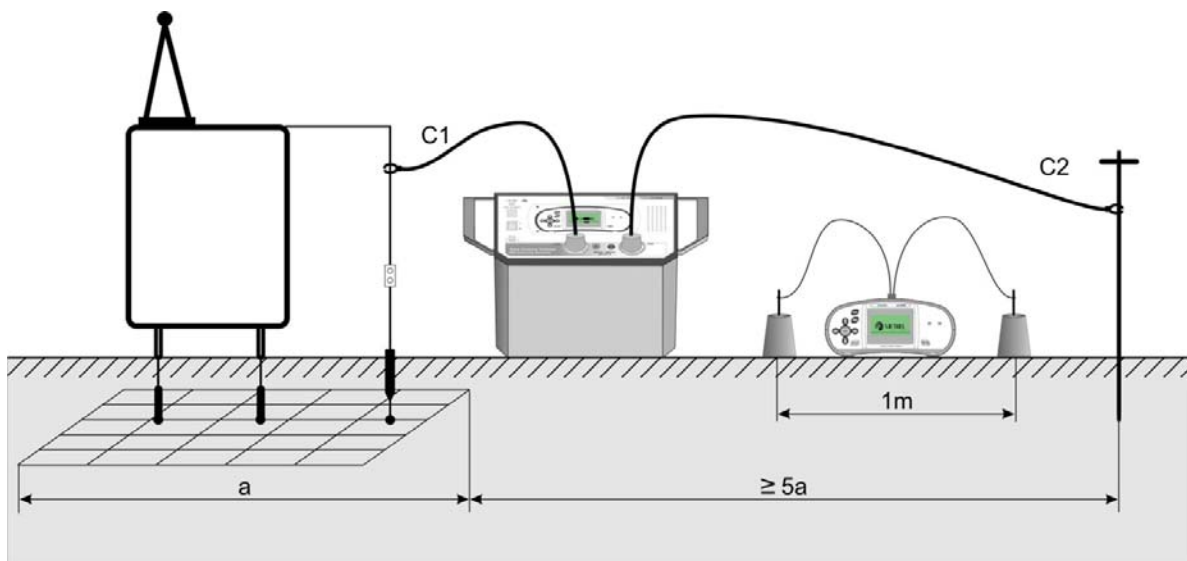

Figure 7.2: Step voltage measurement

Contact voltage

The measurement is performed between an earthed accessible metal part and ground as shown on *Fig. 7.3*. The voltage between the probes is measured by a voltmeter with an internal resistance of 1k Ω that simulates the body resistance.

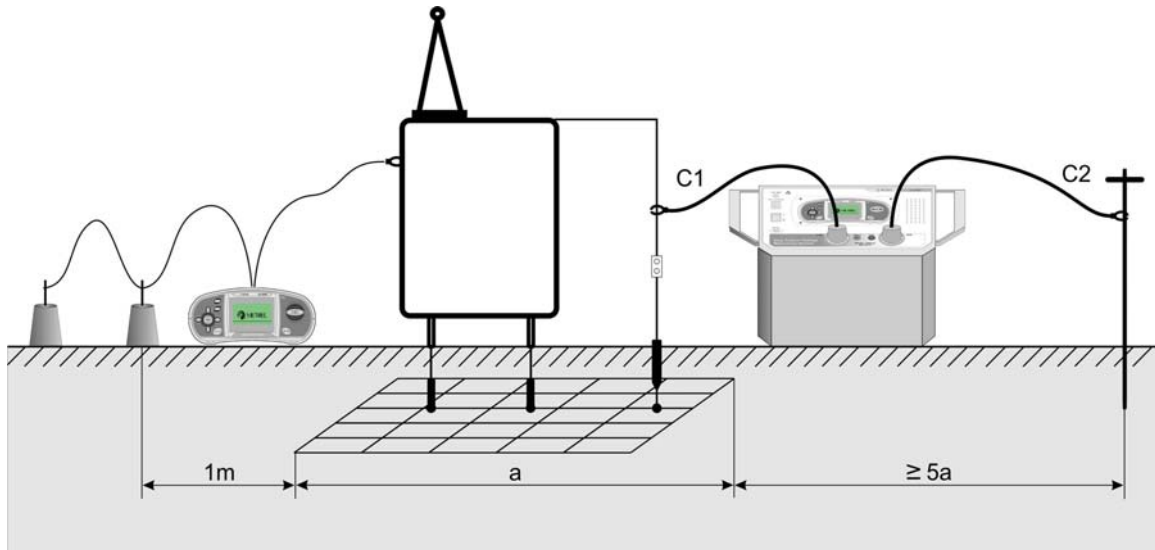

Figure 7.3: Contact voltage measurement

As the test current is usually only a small fraction of the highest fault current the measured voltages must be up scaled according to following equation:

$$U_{S,C} = U_{Measured} \frac{I_{Fault}}{I_{Gen}}$$

$U_{S,C}$calculated step or contact voltage in case of fault current

$U_{Measured}$ measured voltage during the test

I_{Fault}maximal earth current in case of a fault

I_{Gen}injected test current

Earth resistance

For the earthing resistance test a voltage and current probe (serves as auxiliary earth) are used. Because of the voltage funnel it is important that the test electrodes are placed correctly. More information about measuring earth resistance can be found in the METREL handbook: *Guide for testing and verification of low voltage installations*.

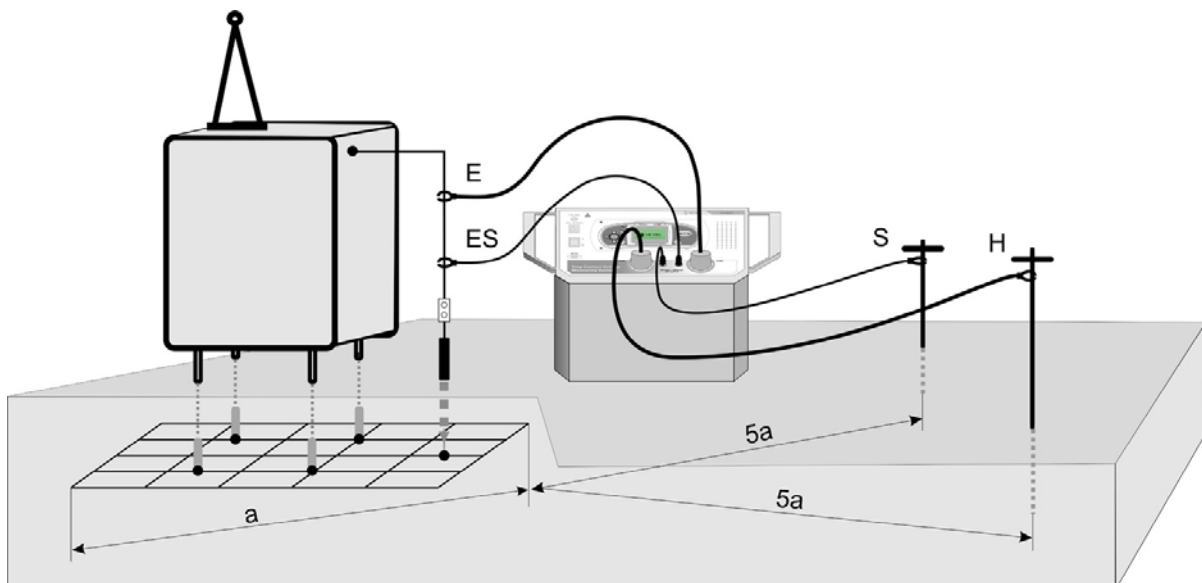

Figure 7.4: Earth resistance measurement

Specific earth resistance

For the specific earth resistance the test current is injected through two current probes (C1/H and C2/E). The voltage probes S and ES must be placed between the current probes (equidistance 'a' between probes must be considered).

Using different distances between the test probes means that the material at different depths is measured. By increasing the distances 'a' a deeper layer of ground material is measured. More information about measuring earth resistance can be found in the METREL handbook: *Guide for testing and verification of low voltage installations*.

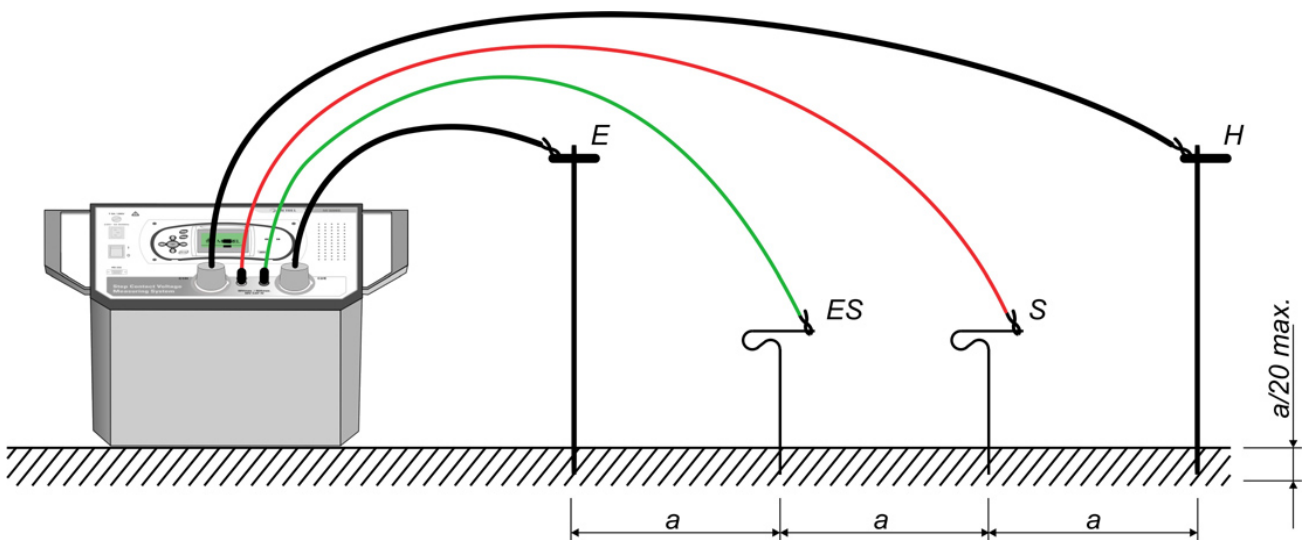

Figure 7.5: Specific earth resistance measurement

7.2 Step and Contact voltage

7.2.1 Injection of test current

Before starting the Step or Contact voltage measurements the test current must be injected in the earth with MI 3295S.

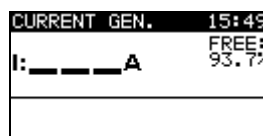

Figure 7.6: Current generator screen

- Connect C2 test lead to the main earthing point
- Place the earth probe
- Connect C1 test lead to the earth probe or another auxiliary earthing point
- Select **CURRENT GEN.** function
- Press the **TEST** key to start the generation of the current.
- Check the value of the current

Connections for step and contact voltage measurement

For connections of the Station see figures 7.2 and 7.3.

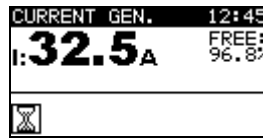

Figure 7.7: Example of the display during generation of current

Note:

- ❑ The output power is set automatically to its available maximum. In case of troubles (generator switches off) refer to chapter 6.6.4 *Output power range*.
- ❑ Incompletely unwound measuring cable can influence on size of generated test current (coil impedance).
- ❑ Usually the resistance of auxiliary probe limits the injected current. The injected current can be increased by placing more probes in parallel.

7.2.2 Synchronization before the test (recommended)

Before starting with the Step and Contact voltage measurements it is recommended to synchronize the Meter and the Station. The synchronization sets the same date and time in both units. Therefore the measured voltages can be correctly scaled after the measurements. If the current is generated during the synchronization its value of is also send to the Meter. For more information see chapter 5.4.5 *Synchronization*.

- ❑ Connect Meter to the Station with the RS232 cable.
- ❑ On Meter, select the **TIME, CURRENT** option in **SYNCHRONIZE** menu and confirm.
Follow the information on the Meter's LCD. If the synchronization succeeded a confirmation beep will follow after short **connecting...** and **synchronizing...** messages.

Connections for synchronization

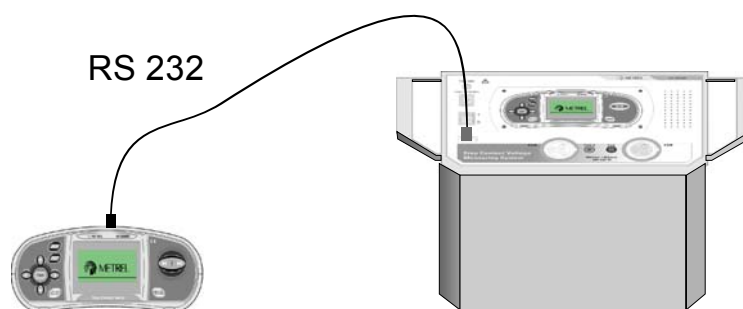

Figure 7.8: Connection of the instruments during synchronization

Note:

- ❑ The measurements can be carried out without synchronization. In this case the measuring current must be set / changed manually. If the injected current is changing during the test the I_{SET} parameter must be adjusted manually. The measurement results cannot be corrected after the measurement.

7.2.3 Step voltage / Contact voltage measurements

While the Station injects the measuring current into earth the Step or Contact voltage tests with the Meter can be carried out.



Figure 7.9: Step and Contact Voltage screens

Test parameters for Step / Contact voltage measurement

I flt	Maximum expected fault current (10 A ... 200 kA)
I set, I gen	Test current manual set (0.20 A ..50 A) or uploaded from Station
R inp	Input resistance (1 MΩ, 1 kΩ)
U lim	Limit step voltage (25 V, 50 V)

Step or Contact voltage measurements,

- ❑ Select **STEP VOLT** or **CONTACT VOLT** function.
- ❑ Set test parameters / limits (optional).
- ❑ For Step voltage place the test electrodes (see chapter 7.1.2 Measurement for more information).
- ❑ For Contact voltage place one test electrode and connect accessible metal part (see chapter 7.1.2 Measurement for more information).
- ❑ Connect the test leads to the instrument.
- ❑ Press the **TEST** key to perform the measurement.
- ❑ Store the result by pressing the **MEM** key (optional).

Note:

- ❑ The measurements can be carried out without synchronization. In this case the measuring current must be controlled and set / changed manually. The results cannot be corrected after the measurement.

Connections for step and contact voltage measurement

For connections see figures 7.2 and 7.3.



Figure 7.10: Examples of step and contact measurement results

Displayed results for step and contact voltage measurements:

U.....calculated Step or Contact voltage

Um.....measured Step or Contact voltage

Note:

- For dry soil or concrete floor, a damp cloth or a film of water should be placed between the probe and the floor.
- It is possible to work with more Meters at the same time.

7.2.4 Synchronization after the test (recommended)

If the Meter and Station were synchronized during the measurements they should be synchronized again after finishing the tests. In this step the values of generated currents (measured with the Station) are downloaded to the Meter. On base of the real generated current data the correction of measured results in the Meter is done. For more information see chapter 5.4.5 *Synchronization*.

- Connect Meter to the Station with the RS232 cable.
- On Meter select **STEP CONTACT VOLT** in **SYNCHRONIZATION** menu and confirm.
- Follow the information on the Meter LCD. If the synchronization succeeds a confirmation beep will follow the **connecting...** and **synchronizing...** messages.

Connections for synchronization

For connection of the instruments see *Figure 7.8*.



Figure 7.11: Examples of synchronization screens

NOT SYNCHRONIZED: number of non-synchronized results.

Note:

- Synchronization of Step / Contact voltage results can last up to several 10 seconds. A bargraph is showing the progress ()

7.3 Earth resistance**7.3.1 Earth resistance measurement**

Figure 7.12: Earth resistance screen

Earth resistance measurements

- Select **EARTH** function using the function selector switch.
- Select **EARTH RE** subfunction using the cursor UP / DOWN keys.
- Connect C2/E test lead and ES potential lead to main earthing point.

- ❑ Connect C1/H test lead to current probe.
- ❑ Connect S potential lead to potential probe.
- ❑ Press the TEST key to perform the measurement.
- ❑ Store the result with MEM key (optional).

Connections for earth resistance measurement

For connections see *Figure 7.4*.



Figure 7.13: Example of earth resistance measurement result

Displayed results for earth resistance measurement:

R.....Earth resistance,
 Rp.....Resistance of S (potential) probe,
 Rc.....Resistance of H (current) probe.

Notes:

- ❑ High resistance of S and H probes could influence the measurement results. In this case the 'Probe' warnings are displayed.
- ❑ High noise currents and voltages in earth could influence the measurement results. The tester displays the 'Noise' warning in this case.
- ❑ Probes must be placed at sufficient distance from the measured object.
- ❑ To view stored earth resistance or specific earth resistance results on PC they must be downloaded to the Meter first. To download the results select Earth results in Synchronize menu. After the results are downloaded the stored data in the Station will be automatically deleted. For connection of the instruments see *Figure 7.8*.

7.3.2 Specific earth resistance measurement

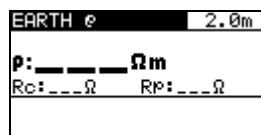

Figure 7.14: Specific earth resistance screen

Specific earth resistance measurements,

- ❑ Select **EARTH** function using the function selector switch.
- ❑ Select **EARTH RE** subfunction using the cursor UP / DOWN keys.
- ❑ Select test parameter using the cursor LEFT / RIGHT keys.
- ❑ Set distance 'a' using the cursor UP / DOWN keys.
- ❑ Connect C1/H and C2/E test leads as current probes.
- ❑ Connect S and ES test leads as potential probes.
- ❑ Press the TEST key to perform the measurement.
- ❑ Store the result with MEM key (optional).

Connections for specific earth resistance measurement

For connections see *Figure 7.5*.



Figure 7.15: Example of specific earth resistance measurement result

Displayed results for earth resistance measurement:

ρ Specific earth resistance,

Rp Resistance of sum (S + ES) of potential probes,

Rc Resistance of sum (C1/H + C2/E) of current probes.

Notes:

- High resistance of current and potential probes could influence the measurement results. In this case the 'Probe' warnings are displayed.
- High noise currents and voltages in earth could influence the measurement results. The tester displays the 'Noise' warning in this case.
- To view stored earth resistance or specific earth resistance results on PC they must be downloaded to the Meter first. To download the results select Earth results in Synchronize menu. After the results are downloaded the stored data in the Station will be automatically deleted. For connection of the instruments see *Figure 7.8*.

8 Data handling

8.1 Memory

Measured results together with all relevant parameters can be stored in the memory of Meter and Station.

- Step and Contact voltage measurements can be stored in the Meter.
- Earth resistance measurements can be stored in the Station and then be downloaded to the Meter.
- Specific earth resistance measurements can be stored in the Station and then be downloaded to the Meter.
- Values of generated currents are automatically stored in the Station's logger.

8.1.1 Data structure

The instrument's memory place is divided into 3 levels each containing 199 locations each. The number of measurements that can be stored into one location is only limited by available memory.

The **data structure field** describes the identity of the measurement (which object and location).

The **measurement field** contains information about type and number of measurements that belong to the selected structure element (object and locations).

This organization helps to handle with data in a simple and effective manner.

The main advantages of this system are:

- Test results can be organized and grouped in a structured manner.
- Simple browsing through structures and results.
- Test reports can be created with no or little modifications after downloading results to a PC.

<pre> RECALL RESULTS OBJECT 001 LOC1 001 > LOC2 001 No.: 1 </pre>	<pre> RECALL RESULTS > OBJECT 001 ----- No.: 7 [13] </pre>	<pre> RECALL RESULTS OBJECT 001 ----- > No.: 7/7 STEP VOLT </pre>
--	---	--

Figure 8.1: Data structure and measurement fields

Data structure field

RECALL RESULTS	Memory operation menu
<pre> OBJECT 001 LOC1 001 LOC2 001 </pre>	Data structure field
OBJECT 001	<ul style="list-style-type: none"> □ 1st level: OBJECT: Default location name (object and its successive number).
LOC1 001	<ul style="list-style-type: none"> □ 2nd level: LOC1: Default location name and its successive number.
LOC2 001	<ul style="list-style-type: none"> □ 3rd level: LOC2: Default location name and its successive number. □ 001: No. of selected element.

Measurement field

No.: 1	No. of measurements in selected location.
No.: 7 [13]	No. of measurements in selected location. [No. of measurements in selected location and its sub locations].
> No.: 7/7	No. of selected test result / No. of all stored test results in selected location.
STEP VOLT	Type of stored measurement in the selected location.

8.1.2 Storing test results

After the completion of a test the results and parameters are ready for storing (💾 icon is displayed in the information field). By pressing the **MEM** key, the user can store the results.

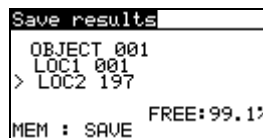

Figure 8.2: Save test menu

Display information

FREE: 99.1%	Memory available for storing results.
-------------	---------------------------------------

Keys in save test menu - data structure field:

Cursor UP / DOWN	Selects the location element (Object / Loc1 / Loc2).
Cursor LEFT / RIGHT	Selects number of selected location element (1 to 199).
MEM	Saves test results to the selected location and returns to the measuring menu.
ESC	Exits back to the measuring menu without save.

Notes:

- ❑ The instrument offers to store the result to the last selected location by default.
- ❑ If the measurement is to be stored to the same location as the previous one just press the MEM key twice.

8.1.3 Recalling test results

In MEMORY menu select RECALL RESULTS.

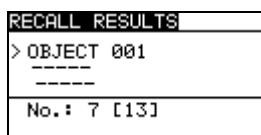

Figure 8.3: Recall menu - data structure field selected

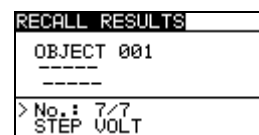

Figure 8.4: Recall menu - measurements field selected

Keys in recall memory menu (data structure field selected):

Cursor UP / DOWN	Selects the location element (Object / Loc1 / Loc2).
Cursor LEFT / RIGHT	Selects number of selected location element (1 to 199).
TEST	Confirms selection and enters measurements field.
ESC	Exits back to main function menu.

Keys in recall memory menu (measurements field selected):

Cursor LEFT / RIGHT	Selects the stored measurement.
TEST	Displays measurement results.
ESC	Exits back to data structure field.

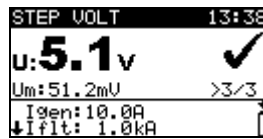

Figure 8.5: Example of recalled measurement result

Keys in recall memory menu (measurement results are displayed)

Cursor LEFT / RIGHT	Displays measurement results stored in selected location.
Cursor UP / DOWN	View all test parameters.
ESC	Exits back to measurement field.

8.1.4 Clearing stored data

Clearing complete memory content

Select CLEAR ALL MEMORY in MEMORY menu. A warning will be displayed.

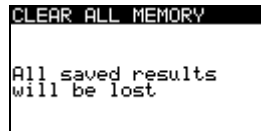

Figure 8.6: Clear all memory

Keys in clear all memory menu

TEST	Confirms clearing of complete memory content.
ESC	Exits back to Settings main menu without changes.

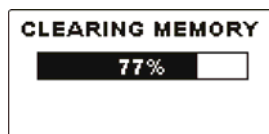

Figure 8.7: Clearing memory in progress

Clearing measurement(s) in selected location

Select DELETE RESULTS in MEMORY menu.

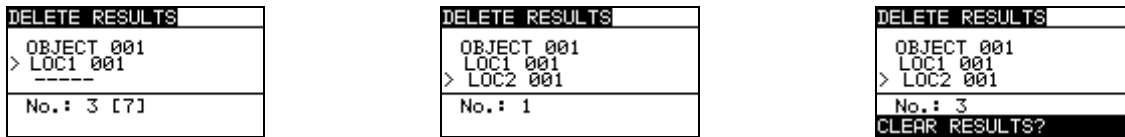

Figure 8.8: Clear measurements menu (data structure field selected)

Keys in delete results menu (data structure field selected):

Cursor UP / DOWN	Selects location element (Object / Loc1 / Loc2).
Cursor LEFT / RIGHT	Selects number of selected location element (1 to 199).
ESC	Exits back to Settings main menu.
MEM	Opens dialog for confirmation to clear result(s) in selected location.

Keys in dialog for confirmation to clear results in selected location:

TEST	Deletes all results in selected location.
ESC	Exits back to delete results menu without changes.

Clearing individual measurements

Select DELETE RESULTS in MEMORY menu.

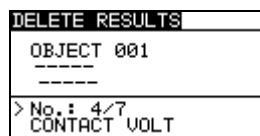

Figure 8.9: Menu for clearing individual measurement (measurement field selected)

Keys in delete results menu (data structure field selected):

Cursor UP / DOWN	Selects location element (Object / Loc1 / Loc2).
Cursor LEFT / RIGHT	Selects number of selected location element (1 to 199).
TEST	Enters measurements field.
ESC	Exits back to Settings main menu.

Keys in delete results menu (measurements field selected):

Cursor LEFT / RIGHT	Selects measurement.
MEM	Opens dialog box for confirmation to clear selected measurement.
ESC	Exits back to data structure field.

Keys in dialog for confirmation to clear selected result(s):

TEST	Deletes selected measurement result.
ESC	Exits back to measurements field without changes.

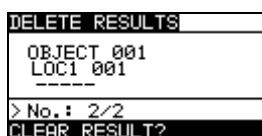

Figure 8.10: Dialog for confirmation

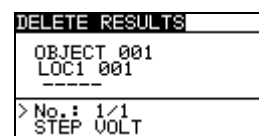

Figure 8.11: Display after measurement was cleared

8.2 Current Logger

If the Meter and Station are synchronized the values of generated currents are stored (together with time and date) in a separated part of the Station's memory. See chapters 5.4.5 *Synchronization* and 7.2.4 *Synchronization after the test* for more information about the advantages of synchronized measurements.

The available place in the logger is shown in the right side of the Current Generator screen (see Fig. 6.2). Once the logger is full its content must be cleared.

8.2.1 Clearing the logger content

Select CLEAR CURRENT LOG in MEMORY menu. A warning will be displayed.

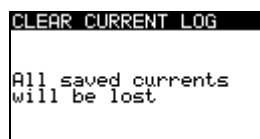

Figure 8.12: Clear current logger

Keys in Clear Logger menu

TEST	Confirms clearing of the complete logger content.
ESC	Exits back to main function menu without changes.

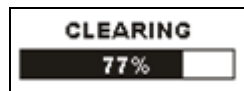

Figure 8.13: Clearing logger in progress

8.3 Communication

Stored results can be transferred to a PC from the Meter. A special communication program on the PC automatically identifies the instrument and enables data transfer between the instrument and the PC.

There are two communication interfaces available on the Meter: USB and RS232.

The instrument automatically selects the communication mode according to detected interface. USB interface has priority.

How to transfer stored data:

- ❑ RS232 communication: connect a PC COM port to the instrument PS/2 connector using the PS/2 - RS232 serial communication cable.
- ❑ USB communication: connect a PC USB port to the instrument USB connector using the USB interface cable.
- ❑ Switch on the PC and the instrument.
- ❑ Run PCSW *HVLink PRO*.
- ❑ The PC and the instrument will automatically recognize each other.
- ❑ The instrument is prepared to download data to the PC.

The program *HVLink PRO* is a PC software running on Windows XP, Windows Vista and Windows 7. Read the file README_HVLinkPRO.txt on CD for instructions about installing and running the program.

Note:

- ❑ USB drivers should be installed on PC before using the USB interface. Refer to USB installation instructions available on installation CD.

9 Maintenance

Unauthorized persons are not allowed to open the instruments. There are no user replaceable components inside the instrument, except the battery under rear cover of Meter (MI 3295M). See chapter 2.2 Battery and charging of MI 3295M.

9.1 Fuse replacement

There is a fuse on the front cover of the MI 3295S Station.

- T 5 A / 250 V, (5 mm × 20 mm)
This fuse prevents from danger in case of a fault inside the instrument.

Warnings:

-  **Disconnect all measuring accessories, switch off the instrument and disconnect mains cord before opening the cover of fuse holder, hazardous voltage inside!**
- Replace blown fuse with original type only, otherwise the instrument may be damaged and/or operator's safety impaired!

Position of a fuse can be seen in *Figure 4.1* in chapter 4.1 *Front panel*.

9.2 Cleaning

No special maintenance is required for the housing. To clean the surface of both instruments Meter (MI 3295M) and Station (MI 3295S) use a soft cloth slightly moistened with soapy water or alcohol. Then leave the instrument to dry totally before use.

Warnings:

- Do not use liquids based on petrol or hydrocarbons!
- Do not spill cleaning liquid over the instrument!

9.3 Periodic calibration

It is essential that the test instrument is regularly calibrated in order that the technical specification listed in this manual is guaranteed. We recommend an annual calibration. Only an authorized technical person can do the calibration. Please contact your dealer for further information.

9.4 Service

For repairs under warranty, or at any other time, please contact your distributor.

10 Technical specifications

10.1 Step voltage, Contact voltage

Measuring range U_m	Resolution	Accuracy
0.01 ÷ 19.99 mV	0.01 mV	±(2 % of reading + 2 dig)
20.0 ÷ 199.9 mV	0.1 mV	
200 ÷ 1999 mV	1 mV	
2.00 ÷ 19.99 V	0.01 V	
20.0 ÷ 59.9 V	0.1V	

Calculated measuring range U	Resolution	Accuracy
0.0 ÷ 199.9 V	0.1 V	calculated value*
200 ÷ 999 V	1 V	

*Displayed Step / Contact voltage is obtained on base of calculation:

$$U_S = U_{\text{meas}} \cdot I_{\text{fault}} / I_{\text{gen}}; \quad U_C = U_{\text{meas}} \cdot I_{\text{fault}} / I_{\text{gen}};$$

I_{fault} (selectable)..... 10 A ... 200 kA

Input resistance (selectable): 1 k Ω , 1 M Ω

Noise cancelation: DSP filtering 55 Hz, 64 dB rejection of 50 (60) Hz noise

Test terminals:

Test connector	Meter
----------------	-------

10.2 Current

Measuring range	Resolution	Accuracy
0.00 ÷ 9.99 A	0.01 A	±(3 % of reading + 5 dig)
10.0 ÷ 99.9 A	0.1 A	±(3 % of reading + 3 dig)

Current generator: 55 A max

Test voltage: < 55 V

Test frequency: 55 Hz

Test terminals:

C1/H - C2/E	Station
-------------	---------

10.3 Resistance to earth

Measuring range	Resolution	Accuracy
0.001 ÷ 1.999 Ω	0.001 Ω	±(2 % of reading + 5 dig)
2.00 ÷ 19.99 Ω	0.01 Ω	
20.0 ÷ 99.9 Ω	0.1 Ω	
100.0 ÷ 199.9 Ω	0.1 Ω	±(5 % of reading)

Open circuit voltage < 50 VAC

Test current..... < 7.5 A

Test signal frequency 55 Hz
 Influence of probe resistance: $\leq \pm(10\% \text{ of reading} + 10 \text{ digits})$
 $(R_c, R_p)_{\max} = (10\ \Omega + 100\ R) \text{ or } 2\ \text{k}\Omega$ (whichever is lower)
 Automatic test of probe resistance yes
 Automatic detection of voltage noise.

Test terminals:

S, ES, C1/H, C2/E	Station
-------------------	---------

10.4 Specific earth resistance

Measuring range (Ωm)	Resolution (Ωm)	Accuracy
0.00 ÷ 9.99	0.01	Calculated value, consider accuracy of Resistance to earth function.
10.0 ÷ 99.9	0.1	
100 ÷ 999	1	
1.00k ÷ 9.99k	0.01k	
10.0k ÷ 99.9k	0.1k	

Wenner method principle with equal distances between test probes:

$$\rho = 2 \cdot \pi \cdot \text{distance} \cdot R..$$

10.5 General data

Station

Rated supply voltage 230 V AC ($\pm 10\%$) / 50 or 60 Hz

Max. power consumption 750 VA

Overvoltage category CAT II / 300 V

Measuring category CAT IV / 50 V

Protection classification Class I

General protection of the instrument:

Fuse T 5 A / 250 V (5 mm x 20 mm)

Pollution degree 3

Degree of protection IP 30

Display 128 x 64 dots matrix display with backlight

Memory 1000 memory locations

Current logger 24 hours min

Communication interface RS232 (for communication with Meter only)

Dimensions (w×h×d) 56.3 cm × 27.5 cm × 25.7 cm

Weight 29.5 kg (without accessories)

Meter

Power supply voltage 9 V_{DC} (6 x 1.5 V battery or accu, size AA)

Operation typical 12h

Charger socket input voltage 12 V ($\pm 10\%$)

Charger socket input current 400 mA max

Battery charging current 250 mA (internally regulated)

Measuring categoryCAT IV / 50 V
Protection classificationdouble insulation
Pollution degree2
Degree of protectionIP 40

Display128 x 64 dots matrix display with backlight
Memory1500 memory locations
Communication interfaceRS232, USB

Dimensions (w×h×d).....23 cm × 10.3 cm × 11.5 cm
Weight1.3 kg (with batteries)

Environmental conditions

Reference temperature range..... 10 °C ÷ 30 °C
Reference humidity range..... 35 % ÷ 65 % RH

Operation conditions

Working temperature range 0 °C ÷ +40 °C
Maximum relative humidity 85 % RH (0 °C ÷ 40 °C), non-condensing

Storage conditions

Temperature range -10 °C ÷ +60 °C
Maximum relative humidity 90 % RH (-10 °C ÷ +40 °C)
80 % RH (40 °C ÷ 60 °C)

Accuracies apply for 1 year in reference conditions. Temperature coefficient outside these limits is 0,2 % of measured value per °C, and 1 digit.